



Cascadable Silicon Bipolar MMIC Amplifier

Technical Data

MSA-1105

Features

- **High Dynamic Range**
Cascadable $50\ \Omega$ or $75\ \Omega$
Gain Block
- **3 dB Bandwidth:**
50 MHz to 1.3 GHz
- **17.5 dBm Typical $P_{1\text{ dB}}$ at 0.5 GHz**
- **3.6 dB Typical Noise Figure at 0.5 GHz**
- **Surface Mount Plastic Package**
- **Tape-and-Reel Packaging Option Available⁽¹⁾**

Note:

1. Refer to PACKAGING section "Tape-and-Reel Packaging for Semiconductor Devices."

Description

The MSA-1105 is a high performance silicon bipolar Monolithic Microwave Integrated Circuit (MMIC) housed in a low cost, surface mount plastic package. This MMIC is designed for high dynamic range in either $50\ \Omega$ or $75\ \Omega$ systems by combining low noise figure with high IP_3 . Typical applications include narrow and broadband linear amplifiers in commercial and industrial systems.

The MSA-series is fabricated using Agilent's 10 GHz f_T , 25 GHz f_{MAX} silicon bipolar MMIC process which uses nitride self-alignment, ion implantation, and gold metallization to achieve excellent performance, uniformity and reliability. The use of an external bias resistor for temperature and current stability also allows bias flexibility.

05 Plastic Package

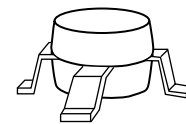

Typical Biasing Configuration

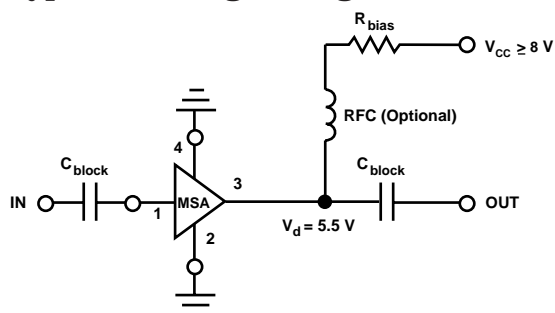

MSA-1105 Absolute Maximum Ratings

Parameter	Absolute Maximum ^[1]
Device Current	80 mA
Power Dissipation ^[2,3]	550 mW
RF Input Power	+13 dBm
Junction Temperature	150°C
Storage Temperature	-65 to 150°C

Thermal Resistance^[2,4]:

$$\theta_{jc} = 125^{\circ}\text{C/W}$$

Notes:

1. Permanent damage may occur if any of these limits are exceeded.
2. $T_{\text{CASE}} = 25^{\circ}\text{C}$.
3. Derate at $8 \text{ mW}/^{\circ}\text{C}$ for $T_{\text{C}} > 124^{\circ}\text{C}$.
4. See MEASUREMENTS section "Thermal Resistance" for more information.

Electrical Specifications^[1], $T_{\text{A}} = 25^{\circ}\text{C}$

Symbol	Parameters and Test Conditions: $I_{\text{d}} = 60 \text{ mA}$, $Z_0 = 50 \Omega$	Units	Min.	Typ.	Max.	
G_{P}	Power Gain ($ S_{21} ^2$)	$f = 0.05 \text{ GHz}$	dB	10.0	12.7	
		$f = 0.5 \text{ GHz}$				12.0
		$f = 1.0 \text{ GHz}$				10.5
ΔG_{P}	Gain Flatness	$f = 0.1 \text{ to } 1.0 \text{ GHz}$	dB		± 1.0	
$f_3 \text{ dB}$	3 dB Bandwidth ^[2]		GHz	1.3		
VSWR	Input VSWR	$f = 0.1 \text{ to } 1.0 \text{ GHz}$			1.5:1	
	Output VSWR	$f = 0.1 \text{ to } 1.0 \text{ GHz}$			1.7:1	
NF	50 Ω Noise Figure	$f = 0.5 \text{ GHz}$	dB	3.6		
$P_{1 \text{ dB}}$	Output Power at 1 dB Gain Compression	$f = 0.5 \text{ GHz}$	dBm	17.5		
IP_3	Third Order Intercept Point	$f = 0.5 \text{ GHz}$	dBm	30.0		
t_{D}	Group Delay	$f = 0.5 \text{ GHz}$	psec	200		
V_{d}	Device Voltage		V	4.4	5.5	6.6
dV/dT	Device Voltage Temperature Coefficient		$\text{mV}/^{\circ}\text{C}$	-8.0		

Notes:

1. The recommended operating current range for this device is 40 to 70 mA. Typical performance as a function of current is on the following page.
2. Referenced from 50 MHz gain (G_{P}).

Part Number Ordering Information

Part Number	No. of Devices	Container
MSA-1105-TR1	500	7" Reel
MSA-1105-STR	10	Antistatic Bag

For more information, see "Tape and Reel Packaging for Semiconductor Devices".

MSA-1105 Typical Scattering Parameters ($Z_0 = 50 \Omega$, $T_A = 25^\circ\text{C}$, $I_d = 60 \text{ mA}$)

Freq. GHz	S_{11}		S_{21}			S_{12}			S_{22}		k
	Mag	Ang	dB	Mag	Ang	dB	Mag	Ang	Mag	Ang	
.0005	.80	-17	19.0	8.94	171	-26.0	.050	51	.81	-16	0.53
.005	.26	-62	13.9	4.98	163	-16.8	.144	15	.26	-64	0.93
.025	.07	-48	12.8	4.36	174	-16.4	.151	4	.08	-52	1.08
.050	.06	-38	12.7	4.33	174	-16.3	.153	2	.06	-48	1.08
.100	.05	-41	12.7	4.31	170	-16.4	.152	3	.06	-52	1.09
.200	.06	-58	12.6	4.26	162	-16.2	.155	5	.08	-73	1.08
.300	.07	-74	12.4	4.19	154	-16.1	.157	7	.10	-91	1.07
.400	.09	-91	12.2	4.10	146	-15.8	.163	8	.12	-105	1.06
.500	.10	-105	12.0	4.00	138	-15.6	.166	8	.14	-116	1.05
.600	.11	-116	11.8	3.88	131	-15.4	.171	10	.17	-126	1.04
.700	.13	-128	11.5	3.76	123	-15.0	.178	11	.18	-135	1.03
.800	.15	-136	11.2	3.63	116	-14.7	.184	11	.21	-144	1.01
.900	.16	-145	10.9	3.49	109	-15.5	.188	11	.22	-151	1.01
1.000	.18	-152	10.5	3.37	102	-14.1	.197	11	.24	-159	1.00
1.500	.28	174	8.8	2.75	72	-13.2	.219	7	.31	170	1.00
2.000	.38	150	7.1	2.28	48	-12.1	.248	0	.34	151	0.99
2.500	.46	133	5.6	1.90	28	-11.9	.254	-4	.38	134	1.02
3.000	.53	118	4.2	1.62	11	-11.6	.262	-8	.40	122	1.04

A model for this device is available in the DEVICE MODELS section.

Typical Performance, $T_A = 25^\circ\text{C}$, $Z_0 = 50 \Omega$

(unless otherwise noted)

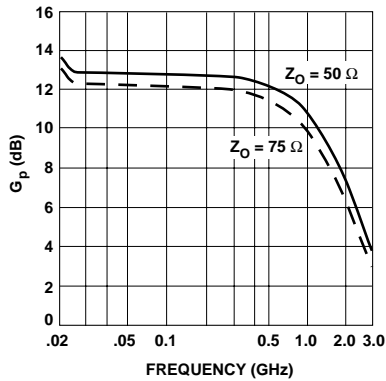

Figure 1. Typical Power Gain vs. Frequency, $I_d = 60 \text{ mA}$.

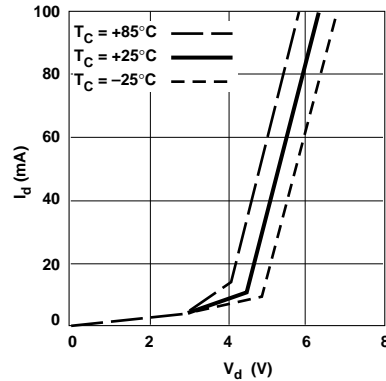

Figure 2. Device Current vs. Voltage.

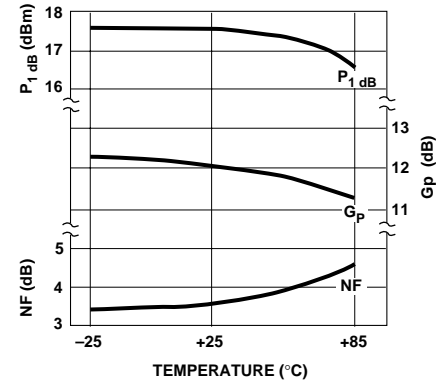

Figure 3. Output Power at 1 dB Gain Compression, Noise Figure and Power Gain vs. Case Temperature, $f = 0.5 \text{ GHz}$, $I_d = 60 \text{ mA}$.

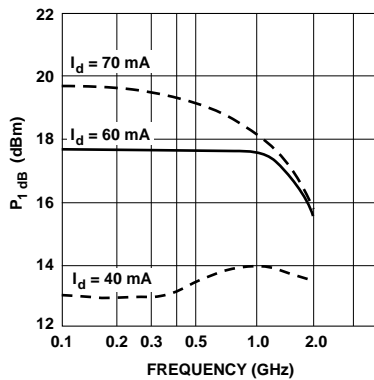

Figure 4. Output Power at 1 dB Gain Compression vs. Frequency.

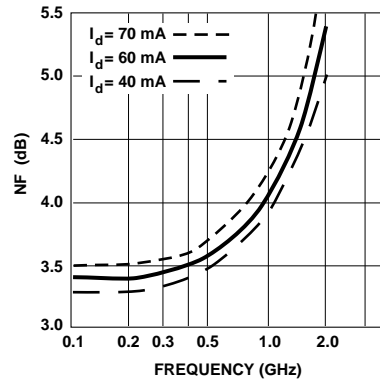
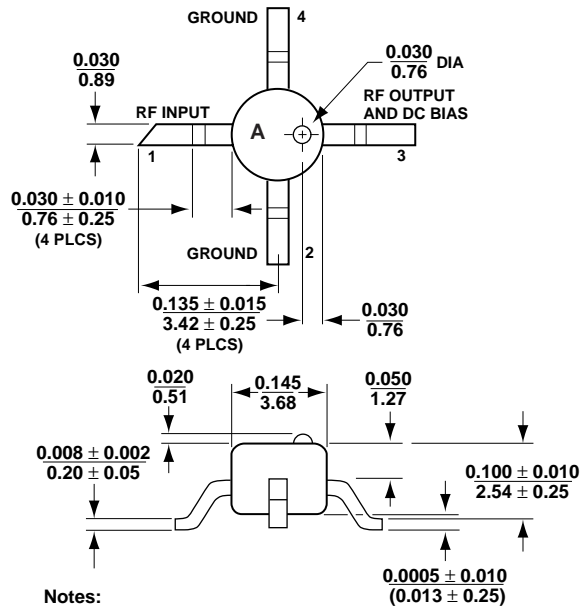

Figure 5. Noise Figure vs. Frequency.



05 Plastic Package Dimensions



Notes:

(unless otherwise specified)

1. Dimensions are $\frac{\text{in}}{\text{mm}}$
2. Tolerances
in .xxx = ± 0.005
mm .xx = ± 0.13